

QLZ06/3000-3038

AC tangential blower

forward-curved

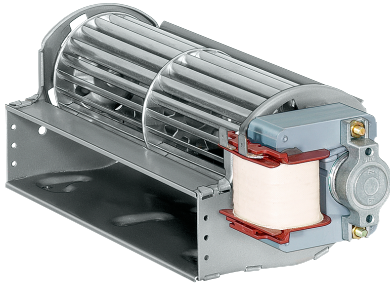

ebm-papst Landshut GmbH

Hofmark-Aich-Straße 25

D-84030 Landshut

Phone +49 (0) 871 707-0

Fax +49 (0) 871 707-465

info3@de.ebmpapst.com

www.ebmpapst.com

Nominal data

Type	QLZ06/3000-3038	
Phase		1~
Nominal voltage	VAC	230
Frequency	Hz	50
Speed	min ⁻¹	1600
Power consumption	W	45
Current draw	A	0.35
Min. ambient temperature	°C	0
Max. ambient temperature	°C	60
Air flow	m ³ /h	230
Pressure increase	Pa	60

ml = Max. load · me = Max. efficiency · fa = Free air · cs = Customer specification · ce = Customer equipment
Subject to change



Technical description

Weight	1.70 kg
Dimensions	60 mm
Insulation class	B on request also F or H
Installation position	Horizontal or vertical with motor on bottom
Cable	Flat plug 6.3 x 0.8

Product drawing

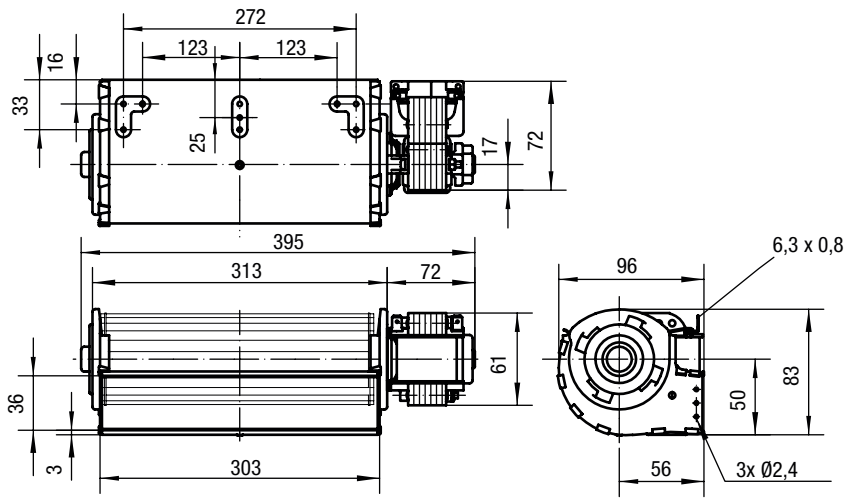

Curves: Air performance

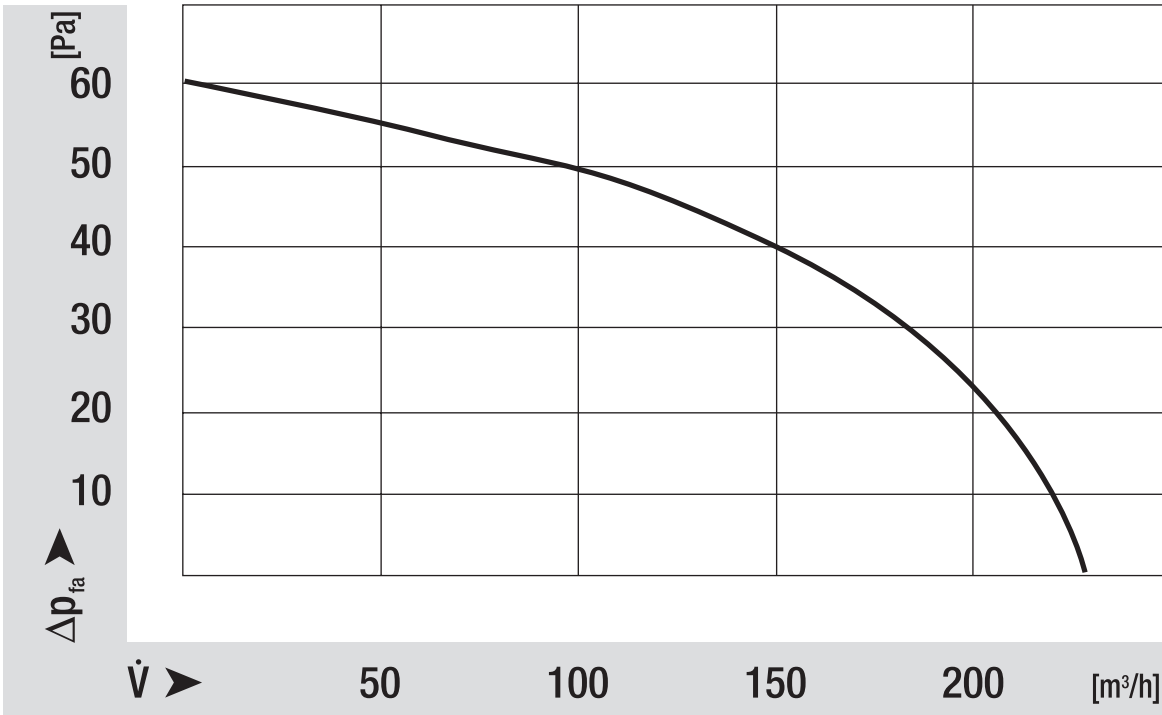

Curves: Speed

